



# Tuyaux Modulaires d'arrosage



**LOC-LINE**®

*L'original depuis 1983*



**KOPAL**

Présentation	02
<b>Buses Haute Pression</b>	03
<b>Tuyaux Modulaires</b>	
Petit Débit 1/4" (Ø 6,35)	04 - 07
Gros Débit 1/2" (Ø 12,7)	08 - 11
<b>Spot-Cool-Line 1/4" et 1/2"</b>	12
Segments longs coudés 1/4" et 1/2"	13
<b>Coffrets 1/4" et 1/2"</b>	14
Distributeurs magnétiques	15
Très Gros Débit 3/4" (Ø 19)	16 - 17
Résistant à l'Acide 1/4" et 1/2"	18 - 19
Pinces d'assemblage 1/4", 1/2" et 3/4"	20
<b>Ecrans de Protection</b>	21
<b>Aspiration</b>	
Tuyaux Ø 62 mm 2-1/2"	22 - 23
<b>Eclairage</b>	
Lampes à led <i>Loc-light</i>	24
Supports de Flash	24

**KOPAL 01**

**ARROSAAGE**

# Tuyaux Articulés 1/4" - Ø 6,35

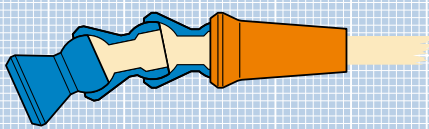

## Segment 1/4" PETIT DEBIT

**Ø intérieur : 6.35 mm**  
**Ø extérieur : 16.25 mm**  
 Longueur utile : 14.7 mm  
 Rayon de courbure mini : R 32 mm  
**Pression maxi : 3.5 Bar** (circuit fermé)  
 Débit : 15 litres / minute  
 Température d'utilisation maxi : 80°C

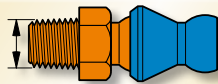
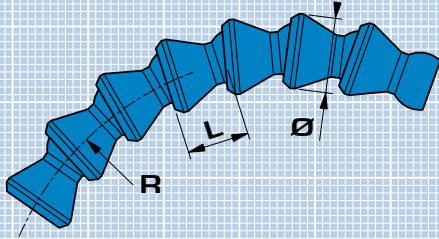

Filetages des raccords	NPT		BSP T	
	Filet à 60°		Filet à 55°	
	Ø - filets/pouce		Ø - filets/pouce	
1/8"	10 mm	28	10 mm	28
1/4"	13,5 mm	18	13,2 mm	19

## Segments Longs

**Segment long, 90 mm** Réf.

**Segment long avec anneau** Pochette de 4 **41-475**

**Segment sans anneau** Pochette de 4 **41-476**  
Sachet de 20 **49-445**



Détails page 18

**Segment coudé à 90°** Réf.

**Segment coudé avec anneau** Pochette de 4 **40-474**

**Segment sans anneau** Pochette de 4 **41-491**  
Sachet de 20 **49-457**

**Anneau de rigidité** Réf. Pochette de 4 **41-477**  
Sachet de 20 **49-446**



## Equipement de base

Raccord 1/4" NPT **40-462**  
Raccord 1/4" BSPT **40-464**

Longueur **325 mm**

1 raccord 1/4"  
1 buse Ø 3,2  
20 segments

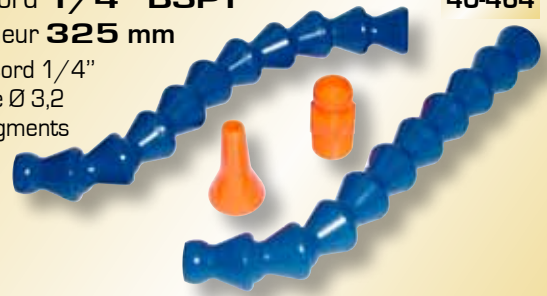

Nouveauté

## Equipement standard

Raccord 1/8" et 1/4" NPT **40-413**

Longueur **325 mm**

2 raccords : 1/4" et 1/8"  
3 buses : Ø 1,6 à 6,35  
20 segments

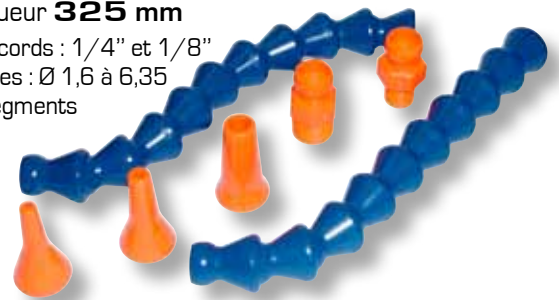

## Equipement complet

Robinet mâle 1/4" NPT **40-460**

Longueur **340 mm**

1 robinet mâle 1/4"  
3 buses Ø 1,6 à 6,35  
1 buse plate 25  
20 segments



## Segments Standards

**Segment 1/4"** Réf.

**285 mm** (20 pièces) **41-401**

**1 mètre** (70 pièces) **41-400**

**7,5 mètres** (530 pièces) **49-420**

**15 mètres** (1060 pièces) **49-421**

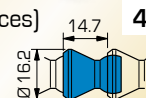

Rotule 1/4

## Assortiment de segments longs

Détails page 13

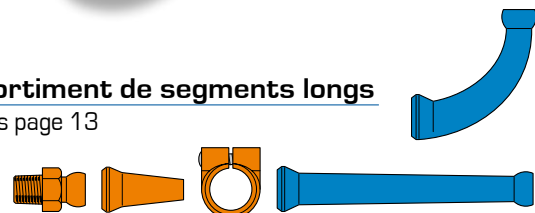

ARROSAJE

# Tuyaux Articulés 1/4" - Ø 6,35

## Raccords filetés et Manchons taraudés

### Raccord fileté

1/8" NPT

Pochette de 4  
Sachet de 50



Réf.



41-405  
49-425

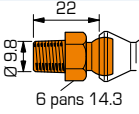

1/4" NPT

Pochette de 4  
Sachet de 50



41-406  
49-426

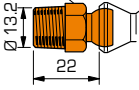

1/8" BSPT (Gaz)

Pochette de 4  
Sachet de 50



41-417  
49-437

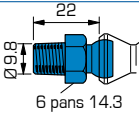

1/4" BSPT (Gaz)

Pochette de 4  
Sachet de 50



41-418  
49-438

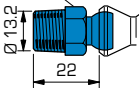

### Manchon taraudé

1/8" NPT vers rotule femelle

Pochette de 4  
Sachet de 20



Réf.



41-411  
49-431

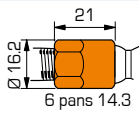

1/8" NPT vers 1/8" NPT

Pochette de 4



40-656

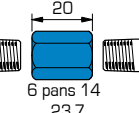

1/4" NPT vers 1/4" NPT

Pochette de 4



40-657

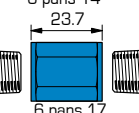

### Réducteur

1/4" vers 1/8" NPT

Pochette de 4



40-655

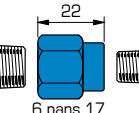

## Robinetts et Segments spéciaux

### Robinet

1/4" NPT mâle

Pochette de 2  
Sachet de 10



Réf.



21-192  
29-452

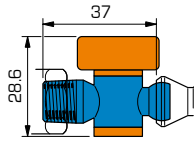

1/4" NPT femelle

Pochette de 2  
Sachet de 10



21-193  
29-453

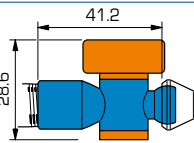

### En ligne

Pochette de 2  
Sachet de 10



21-194  
29-454

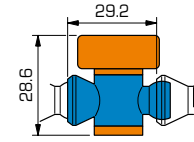

### Métallique

1/4" BSPT  
vers 1/4" BSPT  
1 Robinet



40-310

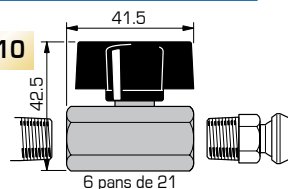

### Segment à jet central

1 trou Ø 2 mm

Pochette de 4



Réf.



41-478

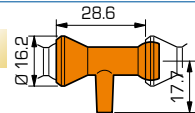

### Bouchon obturateur

Pochette de 4



Réf.

41-480

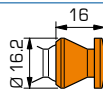

### Cirque

Pochette comprenant :  
15 Segments  
1 Bouchon  
Longueur : 446 mm  
Ø mini inter : 92 mm



41-479

## KOPAL

### Adaptateur Cylindrique

Court

Réf.

Adaptateur Ø 15

Pochette de 4  
Sachet de 20



41-492  
49-458

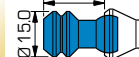

Spécial Haas

Pochette de 4  
Sachet de 20

41-494  
49-460



### Valve anti-retour

Pochette de 2  
Sachet de 10



Réf.



21-191  
29-451

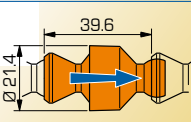

Stoppe l'écoulement de liquide lorsque la pompe est arrêtée. Le liquide est immédiatement disponible et réduit le fonctionnement à sec des outils. Débit minimum garanti : 95%

### Assortiment Adaptateur 1/4"

pour porte-outils avec trous Ø 15  
type Haas

40-476  
40-475

4 Adaptateur court, 4 Adaptateur long  
2 Buse 11mm 5 trous, 2 Buse 11mm  
2 Buse d'équerre Ø 3.2 et Ø 6.35  
2 Buse ronde Ø 3.2 et Ø 6.35  
2 Buse plate 25mm à jet concentré  
4 Anneau de rigidité, 8 x Segment standard  
1 Pince d'assemblage 1/4"



Long, 50.8 mm

Adaptateur Ø 15

Pochette de 4  
Sachet de 20

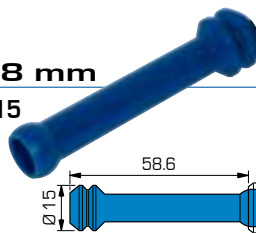

Réf.

41-493  
49-459



Spécial Haas

Pochette de 4  
Sachet de 20

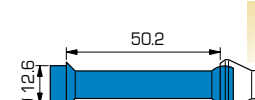

41-495  
49-461





KOPAL 05

ARROSAIGE

# Tuyaux Articulés 1/4" - Ø 6,35

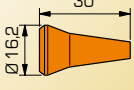
## Buses rondes

Buse ronde	Réf.	
1 trou Ø 1,6 mm Pochette de 4 Sachet de 50	41-402 49-422	
1 trou Ø 3,2 mm Pochette de 4 Sachet de 50	41-403 49-423	
1 trou Ø 6,35 mm Pochette de 4 Sachet de 50	41-404 49-424	

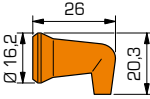
Buse d'équerre	Réf.	
1 trou Ø 1,6 mm Pochette de 4 Sachet de 20	41-470 49-439	
1 trou Ø 3,2 mm Pochette de 4 Sachet de 20	41-471 49-440	
1 trou Ø 6,35 mm Pochette de 4 Sachet de 20	41-472 49-441	

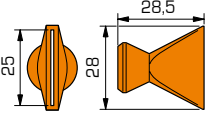
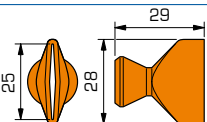

## Buses plates

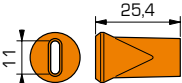
Buse plate 25 x 0,8 mm	Réf.	
Pochette de 2 Sachet de 20	41-407 49-427	
<b>Buse 25 mm à Jet Concentré</b>		
Pochette de 2 Sachet de 20	41-489 49-456	

Buse plate 11 mm	Réf.	
11 x 1 mm Pochette de 4 Sachet de 20	41-483 49-451	
11 x 1,5 mm Pochette de 4 Sachet de 20	41-484 49-452	

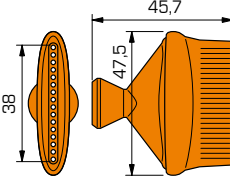
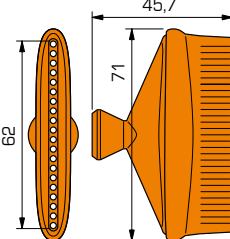
## Buses multi-jets

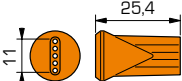
Buse orientable	Réf.	
16 trous Ø 1 mm L : 38 mm Pochette de 2 Sachet de 20	41-481 49-449	
16 trous Ø 1,5 mm L : 38 mm Pochette de 2 Sachet de 20	41-482 49-450	
20 trous Ø 1,9 mm L : 62 mm Pochette de 2 Sachet de 20	41-488 49-455	

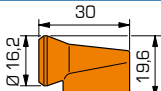
Buse 11 mm	Réf.	
7 trous Ø 1 mm Pochette de 4 Sachet de 20	41-486 49-454	
5 trous Ø 1,5 mm Pochette de 4 Sachet de 20	41-485 49-453	
<b>Buse d'équerre</b>	Réf.	
6 trous Ø 2,5 mm Pochette de 2 Sachet de 20	41-473 49-442	

## Assortiments de Buses

Assortiment de 16 Buses	Réf.	
Pochette	41-490	
3 Buses rondes : Ø 1,6 - 3,2 - 6,35		
3 Buses d'équerres : Ø 1,6 - 3,2 - 6,35		
4 Buses plates : L 25 x 0,8 - 25 à jet concentré L 11 x 1 - L 11 x 1,5		
5 Buses multi-jets : 16 trous Ø 1 - 16 trous Ø 1,5 20 trous Ø 1,9 7 trous Ø 1 - 5 trous Ø 1,5		
1 Buse d'équerre multi-jet : 6 trous Ø 2,5		

Assortiment de 4 Buses d'équerres	Réf.	
Pochette de 4 buses Ø 1,6 - 3,2 - 6,35 - 6 trous Ø 2,5	41-474	



## Pinces d'assemblage

1 Pince pour Loc-line 1/4"	78-001
2 Pinces : 1 en 1/4" et 1 en 1/2"	78-003

Utilisez le plus souvent possible pour assembler et déboîter le tuyau en toute sécurité.

# Tuyaux Articulés 1/4" - Ø 6,35

## Distributeurs et éléments de liaison

### Élément de liaison

Réf.  

**Dérivation en Y**  
1/4" vers 1/4"  
Pochette de 2  
Sachet de 20



**41-408**  
**49-428**

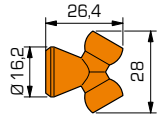

**Manchon double femelle**  
Pochette de 4  
Sachet de 20



**41-409**  
**49-429**

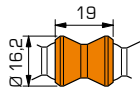

**Coude mâle-femelle**  
1/4" vers 1/4"  
Pochette de 2  
Sachet de 20



**41-415**  
**49-435**

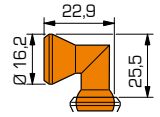

**Dérivation en T**  
1/4" vers 1/4"  
Pochette de 2  
Sachet de 20



**41-416**  
**49-436**

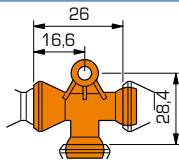

### Support pour Manifold

Pochette de 2

**21-195**

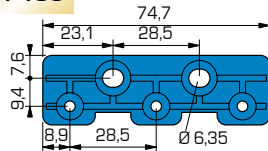

**LOC-LINE noir disponible**  
sur commande 

### Distributeur standard



Réf.

#### Manifold

1 support avec vis  
3 dérivation en té  
1 coude mâle-femelle



**21-199**

### Distributeur complet



Réf.

#### Manifold

1 support avec vis  
3 dérivation en té  
1 coude  
5 robinets en ligne



**21-198**

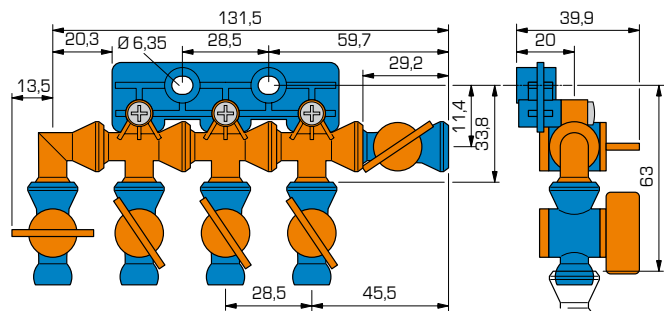

## Distributeurs métalliques magnétiques

### Support magnétique

1 corps aluminium anodisé  
Ø 54 mm avec 4 sorties  
1/4" NPT femelle  
1 raccord tube  
3 bouchons 1/4" NPT

*Plus de modèles page 15*

**40-305**

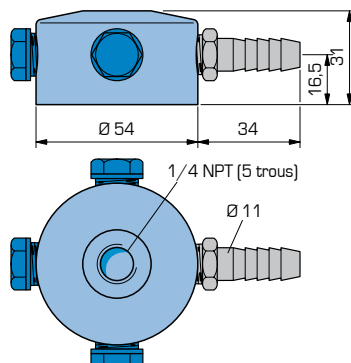

### Support magnétique équipé

comprenant :

1 support 40-305  
2 équipements 40-460

**40-306**



**LOC-LINE®**

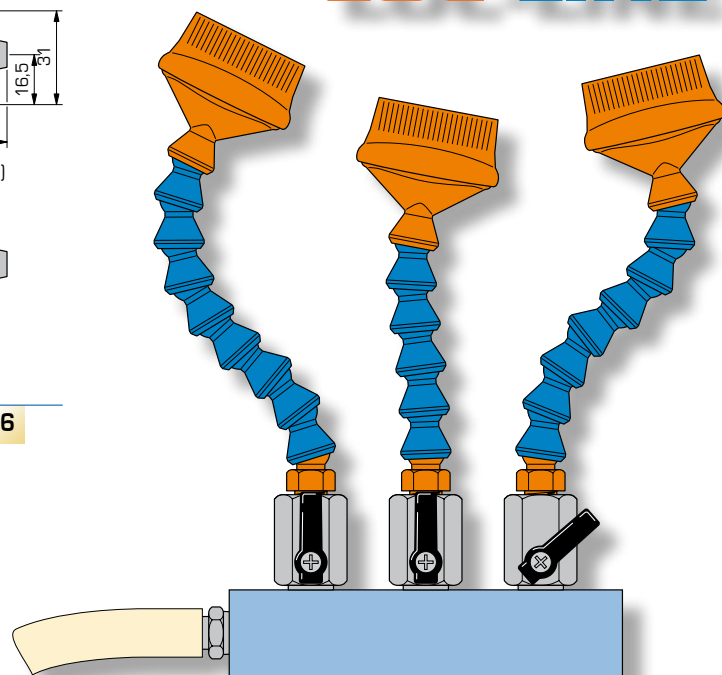

**KOPAL 07**

**ARROSAGE**

# Tuyaux Articulés 1/4" et 1/2"

## Equipement N°1

- 1 Raccord tournant en aluminium BSPT
- 10 ou 12 Segments rotules
- 1 Buse ronde

Réf.

**Raccord 1/4" - LOC-LINE 1/4" 40-850**

Longueur 205 mm, Buse Ø 3.2mm

**Raccord 1/2" - LOC-LINE 1/2" 50-850**

Longueur 340 mm, Buse Ø 9mm

## Equipement N°2

- 1 Raccord tournant en aluminium BSPT
- 1 Robinet en ligne + 2 Anneaux de rigidité
- 10 ou 12 Segments rotules
- 1 Buse ronde

Réf.

**Raccord 1/4" - LOC-LINE 1/4" 40-852**

Longueur 235 mm, Buse Ø 3.2mm

**Raccord 1/2" - LOC-LINE 1/2" 50-852**

Longueur 390 mm, Buse Ø 9mm

## Spot-Cool-Line

**Raccord en aluminium de grande rigidité**



N°1

**Rotation à 360°**



N°2



N°4

**Haute Pression**



N°3

## Equipement N°3

- 1 Raccord tournant en aluminium BSPT
- 4 Segments longs coudés + 4 Anneaux de rigidité
- 1 Buse plate à jet concentré

Réf.

**Raccord 1/4" - LOC-LINE 1/4" 40-854**

Longueur 250 mm, Buse plate 25mm

**Raccord 1/2" - LOC-LINE 1/2" 50-854**

Longueur 440 mm, Buse plate 30mm

## Raccord tournant BSPT

Réf.

1/4" pour LOC-LINE 1/4" (6.35)

LDL14M

1/2" pour LOC-LINE 1/2" (12.7)

LDL12M

**Raccord en aluminium haute pression**

**Grande rigidité**

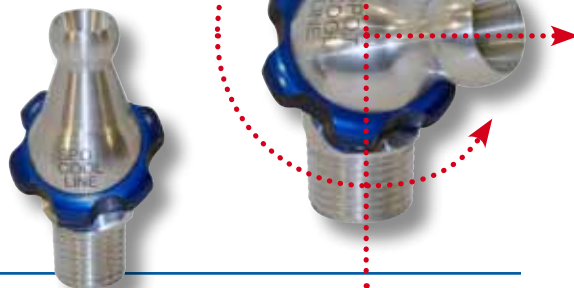

## Equipement N°4

- 1 Raccord tournant en aluminium BSPT
- 1 Robinet en ligne + 1 Anneau de rigidité
- 4 Segments longs coudés + 4 Anneaux de rigidité
- 1 Buse plate à jet concentré

Réf.

**Raccord 1/4" - LOC-LINE 1/4" 40-856**

Longueur 280 mm, Buse plate 25mm

**Raccord 1/2" - LOC-LINE 1/2" 50-856**

Longueur 485 mm, Buse plate 30mm

# Tuyaux Articulés 1/4" et 1/2"

## Segments rotules longs coudés



**Segment long coudé à 90°** 1/4" - 6.35 Réf.

Pochette de 4 **41-491**  
Sachet de 20 **49-457**

**Anneau de rigidité**

Pochette de 4 **41-477**  
Sachet de 20 **49-446**

**Assortiment**

4 Segments coudés, 4 Anneaux **40-474**

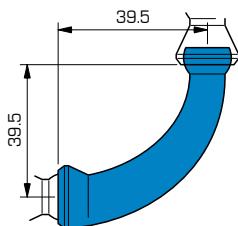

**Segment long coudé à 90°** 1/2" - 12.7 Réf.

Pochette de 4 **51-896**  
Sachet de 20 **59-899**

**Anneau de rigidité**

Pochette de 4 **51-834**  
Sachet de 20 **59-884**

**Assortiment**

4 Segments coudés, 4 Anneaux **50-874**

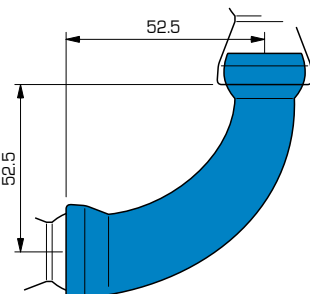

*Encore plus rigide, même sur de grandes longueurs.*

**Assortiment coudé 1/4"** Réf. **40-472**  
comprenant :  
4 segments coudés  
4 anneaux  
3 buses rondes Ø 1.6, 3.2, 6.35  
2 raccords 1/8" - 1/4" NPT

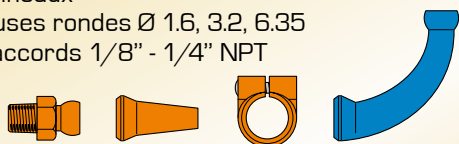

**Assortiment coudé 1/4"** Réf. **40-473**  
comprenant :  
2 segments coudés  
2 segments longs  
4 anneaux  
3 buses rondes Ø 1.6, 3.2, 6.35  
2 raccords 1/8" - 1/4" NPT



**Assortiment coudé 1/2"** Réf. **50-872**  
comprenant :  
4 segments coudés  
4 anneaux  
3 buses rondes Ø 6.35, 9.05, 12.7  
2 raccords 3/8" - 1/2" NPT

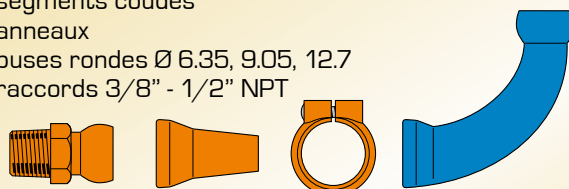

**Assortiment coudé 1/2"** Réf. **50-873**  
comprenant :  
2 segments coudés  
2 segments longs  
4 anneaux  
3 buses rondes Ø 6.35, 9.05, 12.7  
2 raccords 3/8" - 1/2" NPT



# Coffrets 1/4" - 1/2"



## KOPAL

● Une large gamme de références sélectionnée pour vous

Coffret	Réf.
Coffret 1/4" (119 éléments)	40-001
Coffret 1/2" (72 éléments)	50-001

**LOC-LINE** est un système de tuyaux flexibles qui convient à de nombreux domaines professionnels. De multiples buses, raccords et accessoires sont proposés dans 4 diamètres : 1/4" 1/2" 3/4" et 2" 1/2". LOC-LINE est conditionné en pochettes de quelques unités, en sachets par quantité et en bobines.











**LOC-LINE** est également disponible en différentes couleurs (voir les pictogrammes après chaque désignation). Quelle que soit votre demande, le kit souhaité existe parmi les 400 références qui constituent la gamme.

#### Les couleurs LOC-LINE.

A l'origine, le code-couleur orange-bleu fut choisi, car le bleu est la couleur préférée de 90 % des êtres humains et convient à l'univers industriel. Les buses oranges ont été choisies dans un souci de sécurité.

#### Le saviez-vous ?

Quand nous avons lancé le Loc Line en 1983, il y avait 7 références. Aujourd'hui, on en compte 400 ! déclinées en 6 couleurs : bleu, orange pour le traditionnel ; noir, gris, blanc et rouge pour customiser votre installation.

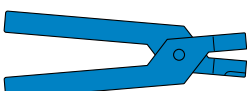
	1/4"	1/2"
Composition	<b>Qté. par coffret</b>	<b>Qté. par coffret</b>
<b>Segment rotule</b> 	<b>80</b> (1140 mm)	<b>36</b> (795 mm)
Segment long 	<b>4</b> (360 mm)	<b>4</b> (360 mm)
Anneau de rigidité 	<b>4</b>	<b>4</b>
<b>Raccord</b> 	<b>4</b> (1/8" NPT)	<b>4</b> (3/8" NPT)
	<b>4</b> (1/4" NPT)	<b>4</b> (1/2" NPT)
Raccord femelle 	<b>2</b> (1/8" NPT)	<b>2</b> (3/8" NPT)
	<b>2</b> (3/8" NPT)	
Robinet fileté 	<b>1</b> (1/4" NPT)	<b>1</b> (1/2" NPT)
Robinet en ligne 	<b>1</b>	<b>1</b>
Dérivation en Y 	<b>2</b>	<b>2</b>
<b>Buse ronde</b> 	<b>4</b> (Ø 1,6 mm)	<b>3</b> (Ø 6,35 mm)
	<b>4</b> (Ø 3,2 mm)	<b>3</b> (Ø 9,5 mm)
	<b>4</b> (Ø 6,35 mm)	<b>3</b> (Ø 12,7 mm)
Adaptateur 		<b>2</b> (1/2 vers 1/4)
Buse plate 	<b>2</b> (25 x 0,8 mm)	<b>2</b> (31 x 4 mm)
Pince 	<b>1</b>	<b>1</b>



# Distributeurs magnétiques



## Sortie NPT - 3 Horizontales - 1 Verticale

Nombre de sortie	A	B	C	D	E	Réf.
4	1/4"	∅ 54	16,5	31	∅ 11	40-305

## Sortie BSPT Horizontale

Nombre de sortie	A	B	C	D	E	Réf.
1	1/4"					40-301
1	3/8"	∅ 75	56	57	∅ 11	50-301

## Sortie BSPT Verticale

Nombre de sorties	A	B	C	D	E	Réf.
1	1/4"	∅ 75	80		∅ 11	40-300
1	3/8"					50-300
3	1/4"					40-303
3	3/8"	130x40	37,5	63,5	∅ 11	50-303
4	1/4"					40-304
4	3/8"	170x40	38,5	63,5	∅ 11	50-304

● Robinets métalliques

● Supports à fort magnétisme

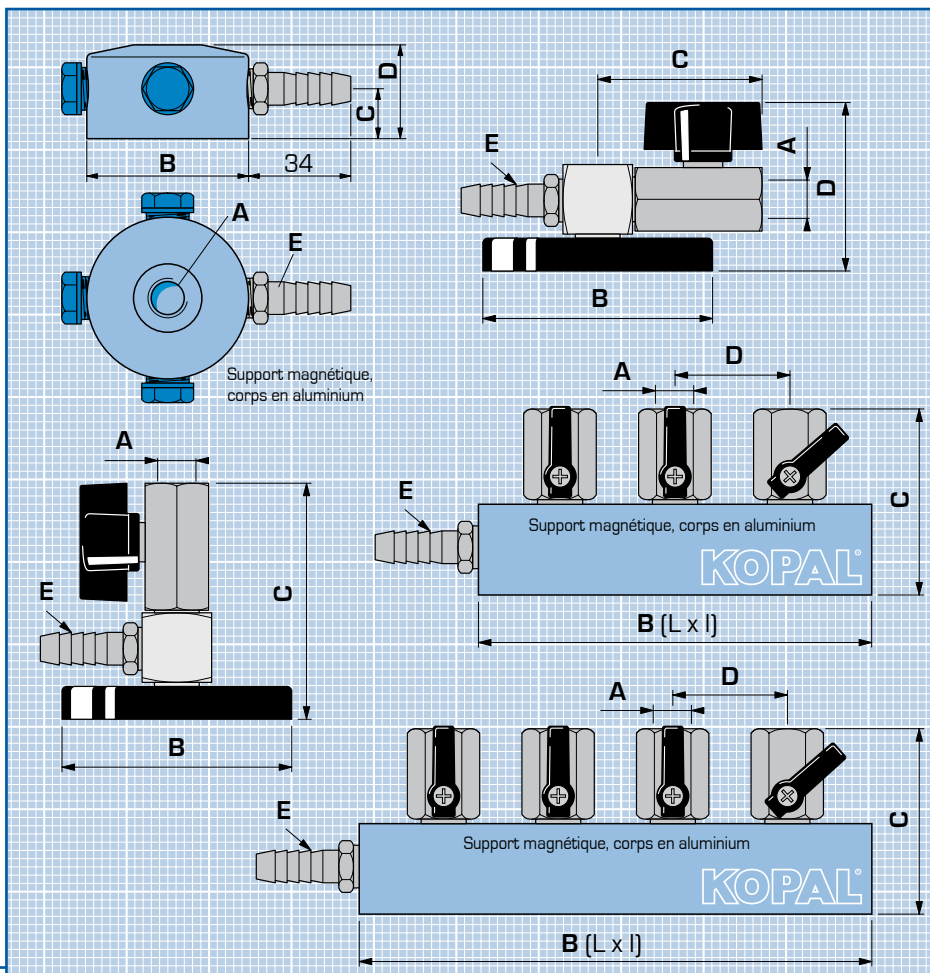
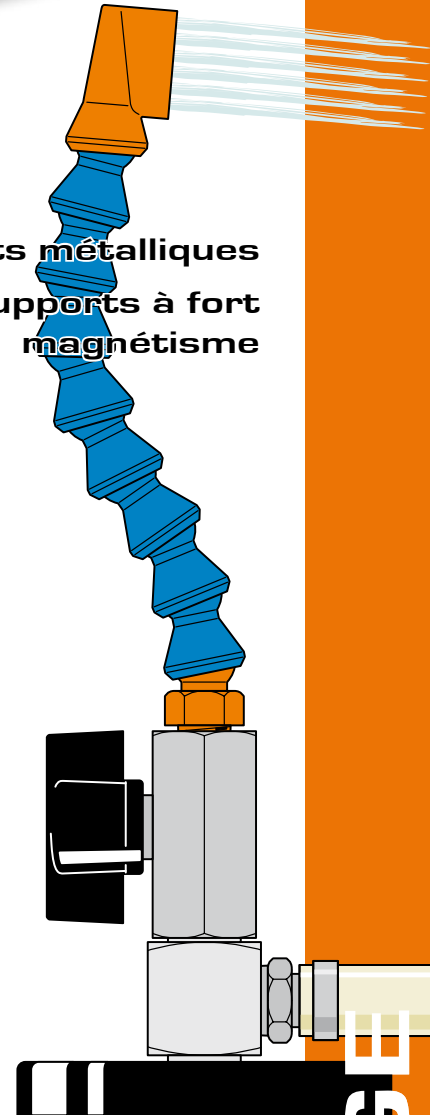

KOPAL 15

ARROSAGE

# Pinces d'assemblage

## Pour tuyaux articulés 1/4" - 1/2" - 3/4"



● **Gagnez du temps en travaillant en toute sécurité !**



**Pinces d'assemblage**  
Pince pour petit débit (1/4")

Réf.  
**78-001**

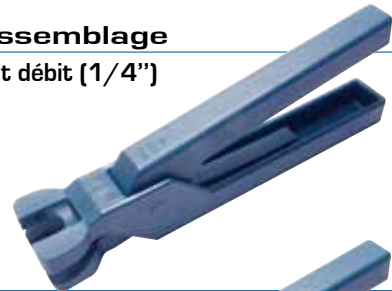

Pince pour gros débit (1/2")

**78-002**

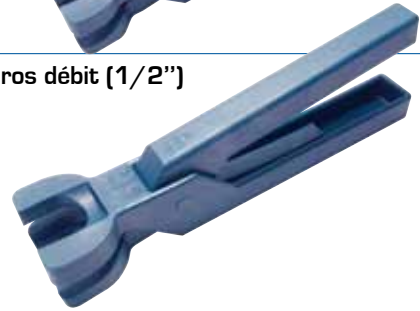

Jeu de 2 pinces pour petit et gros débit (1/4" et 1/2")

**78-003**

Pince pour très gros débit (3/4")

**78-004**

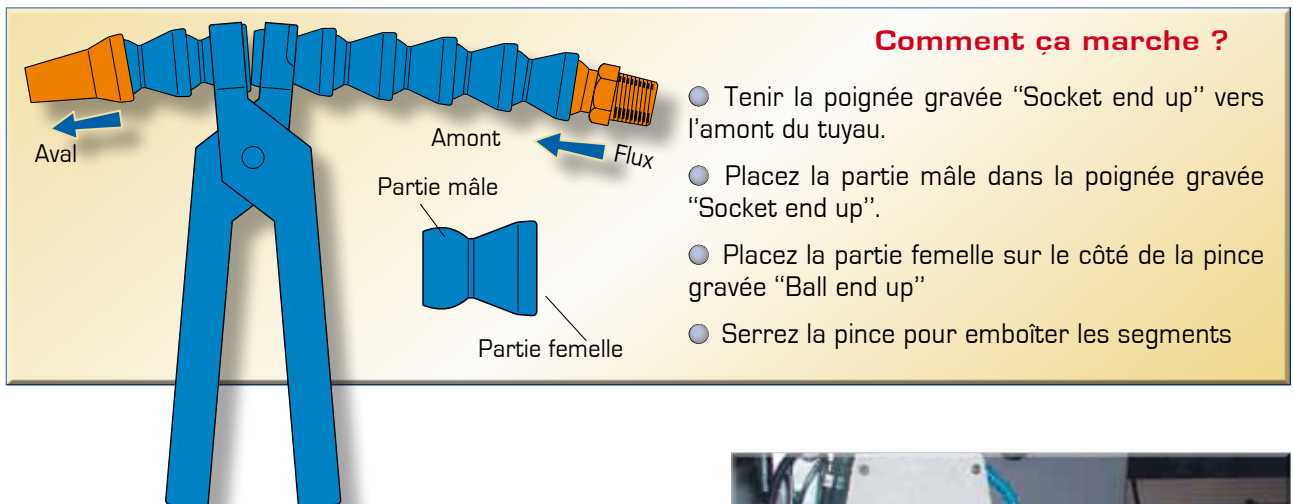
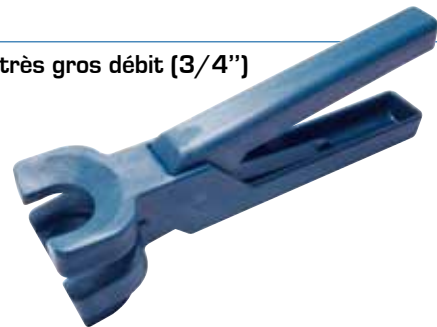

**i** Les pinces pour Loc-Line 1/4" et 1/2" permettent aussi de déboîter le tuyau à l'endroit voulu.

- Ecartez la pince pour déboîter les segments

